

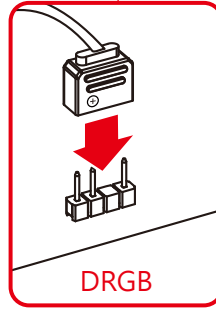

Bitspower®

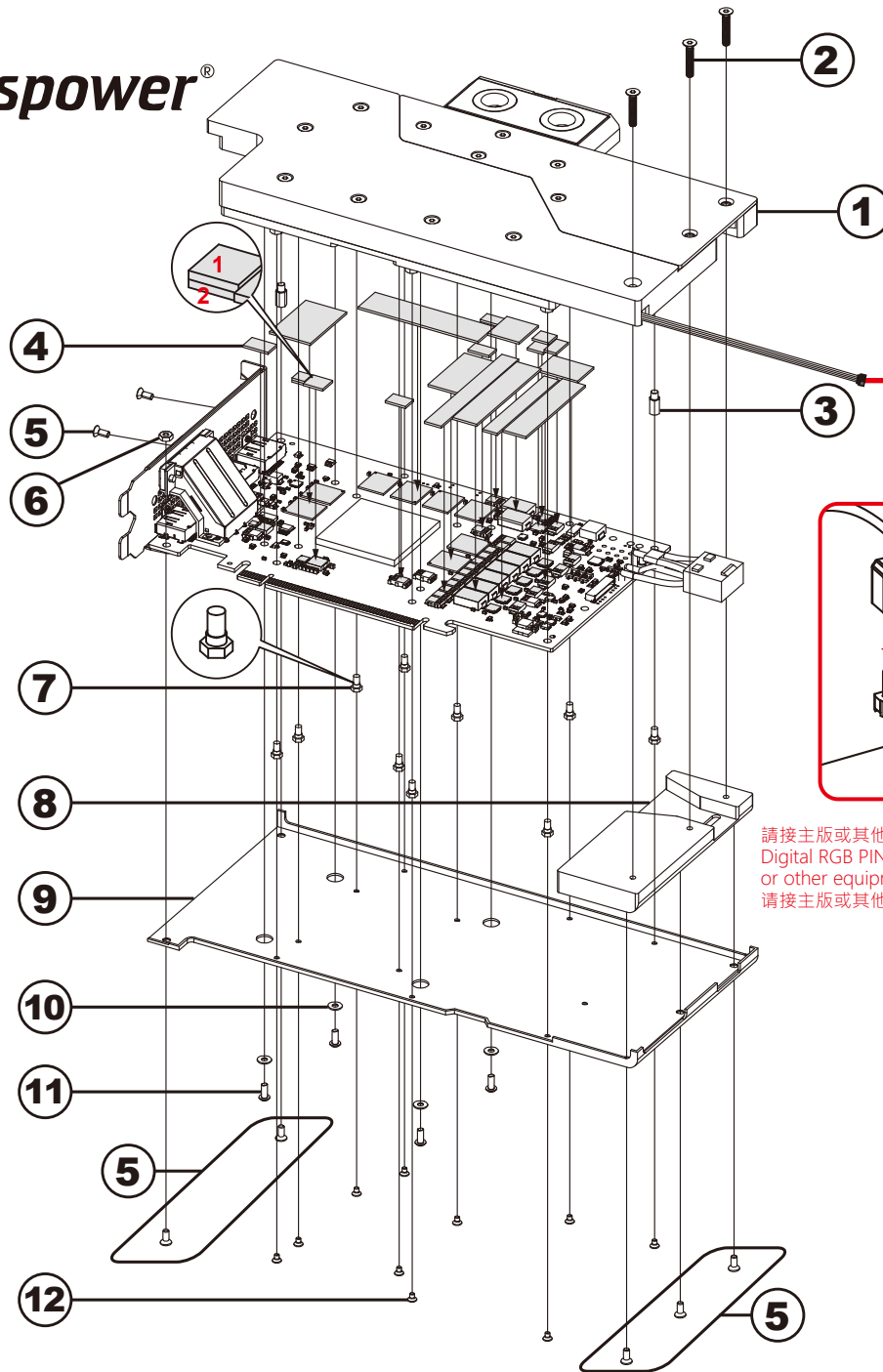

請接主版或其他設備的DRGB插槽
Digital RGB PIN on motherboard
or other equipment.
請接主版或其他设备的DRGB插槽

Design for NVIDIA GEFORCE RTX 2070

配件

①	BP-VG2070RD	1 組	⑨	原廠背板 不包括	1 片
②	M3 x 16 毫米F頭內六角螺絲	3 支	⑩	塑膠墊片	4 片
③	墊高螺絲	2 支	⑪	M2.5 x 6 毫米半圓頭內六角螺絲	4 支
④	1.0 毫米導熱墊片	4 片	⑫	M2 x 3 毫米螺絲 不包括	10 支
⑤	M2.5 x 6 毫米螺絲 不包括	7 支			
⑥	M2.5螺帽	1 個			
⑦	原廠墊高螺絲 不包括	10 支			
⑧	模塊	1 個			

Accessories

①	BP-VG2070RD	1 SET	⑨	Original backplane Not included	1 PCS
②	M3 x 16 mm Flat Head socket screw	3 PCS	⑩	Plastic spacer	4 PCS
③	Booster screw	2 PCS	⑪	M2.5 x 6mm Button head socket screw	4 PCS
④	1.0 mm Thermal pad	4 PCS	⑫	M2 x 3 mm screw Not included	10 PCS
⑤	M2.5 x 6 mm screw Not included	7 PCS			
⑥	M2.5 nut	1 PCS			
⑦	Original booster screw Not included	10 PCS			
⑧	Module	1 PCS			

配件



①	BP-VG2070RD	1 組	⑨	原厂背板 不包括	1 片
②	M3 x 16毫米F頭內六角螺絲	3 支	⑩	塑膠墊片	4 片
③	墊高螺絲	2 支	⑪	M2.5 x 6 毫米半圓頭內六角螺絲	4 支
④	1.0 毫米導熱墊片	4 片	⑫	M2 x 3 毫米螺絲 不包括	10 支
⑤	M2.5 x 6 毫米螺絲 不包括	7 支			
⑥	M2.5螺帽	1 個			
⑦	原廠墊高螺絲 不包括	10 支			
⑧	模塊	1 個			



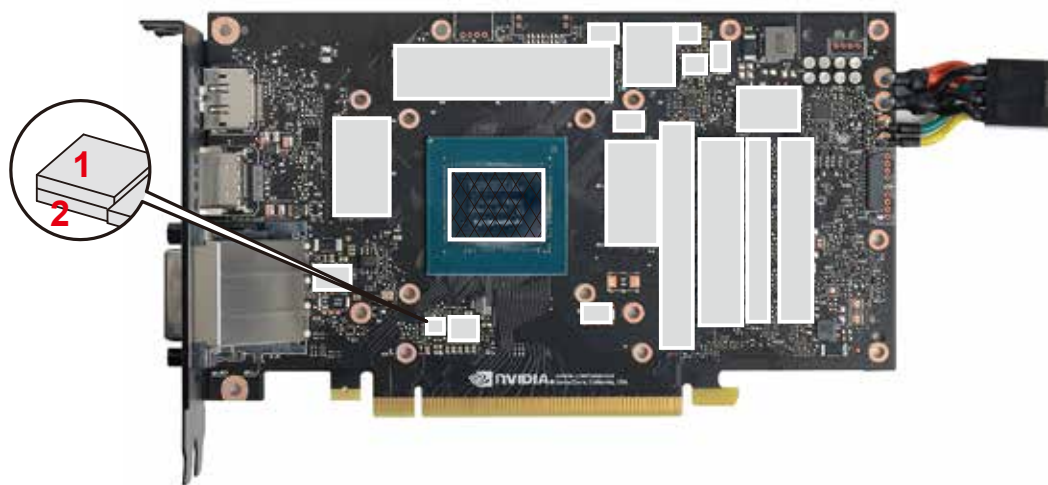

本公司保留對產品的設計更改以及解釋的權力。如有更動恕不另行通知。產品顏色與配件以實物為準。
Bitspower reserves the right to change the product design and interpretations. These are subject to change without notice. Product colors and accessories are based on the actual product.
本公司保留对产品的的设计更改以及解释的权力。如有更动恕不另行通知。产品颜色与配件以实物为准。





導熱墊片和導熱膏的正確應用位置

-  適量使用導熱膏
-  1 mm 導熱墊片

Applying the thermal pad and thermal paste on correct positions.

-  Using appropriate amount of thermal paste.
-  1 mm Thermal pad

导热垫片和导热膏的正确应用位置

-  适量使用导热膏
-  1 毫米导热垫片

 注意·跑水前·請先確認所有零件已安裝在正確的位置上·在不開主機·單開水泵的情況下·進行24小時的跑水測試·確保無漏水情況後再開主機·避免發生漏水而導致電腦零件的損壞。

 Before filling in the water, please make sure all the components are installed correctly. To prevent any leakage which may damage the PC components, please perform a 24-hour leaking test with only the pump connected to the power supply .

 注意·跑水前·請先確認所有零件已安裝在正確的位置上·在不開主機·單開水泵的情況下·進行24小時的跑水測試·確保無漏水情況後再開主機·避免發生漏水而導致電腦零件的損壞。



Bitspower®

注意：Bitspower建議消費者使用蒸餾水、純淨水，加入Bitspower的染劑作為水冷液使用；如客戶自行選購的水冷液導致電鍍層剝落、水道堵塞、水泵轉



動不正常、水箱管破裂或密封圈變型以致漏水等及其它不可抗力之問題時，消費者自行承擔相關產品責任。

未注水前，請勿啟動水泵電源。

Notice:Bitspower recommends that consumers add the Bitspower dye to distilled water or purified water for their water-cooling liquid. If the



consumer chooses different water-cooling liquids, the resulting impurities may cause peeling of the coating on some of the hardware, water channels blockage by built-up residue, improper operation of the water pump, water tank tube breakage, and o-rings deformation leading to leakage. Any issues related to the use of inappropriate water-cooling liquid will be the responsibility of the consumer.

Do not turn on the pump if the reservoir is empty.

注意：Bitspower 建议消费者使用蒸馏水、纯净水，加入Bitspower的染剂作为水冷液使用；如客户自行选购的水冷液导致电镀层剥落、水道堵塞、水泵转



动不正常、水箱管破裂或密封圈变型以致漏水等及其它不可抗力之问题时，消费者自行承担相关产品责任。

未注水前，请勿启动水泵电源。



注意·跑水前·請先確認所有零件已安裝在正確的位置上·在不開主機·單開水泵的情況下·進行24小時的跑水測試·確保無漏水情況後再開主機·避免發生漏水而導致電腦零件的損壞。

Before fill in water,please make sure all the component be installed correctly,avoidingleaking happen and destroy the PC component.

注意·跑水前·請先確認所有零件已安裝在正確的位置上·在不開主機·單開水泵的情況下·進行24小時的跑水測試·確保無漏水情況後再開主機·避免發生漏水而導致電腦零件的損壞。

本公司保留對產品的設計更改以及解釋的權力·如有更動恕不另行通知·產品顏色與配件以實物為準。

Bitspower reserves the right to change the product design and interpretations. These are subject to change without notice. Product colors and accessories are based on the actual product.

本公司保留對產品的設計更改以及解釋的權力·如有更動恕不另行通知·產品顏色與配件以實物為準。