

請接**1**主版**或****2**其他設備的DRGB插槽。
 Digital RGB PIN on **1** motherboard **or** **2** other equipment.
 請接**1**主版**或****2**其他設備的DRGB插槽。

1  主版
motherboard
主版

2  BPTA-DRGBMFC
DRGB控制器(不包括)
DRGB Multi Function Controller(Not included)
DRGB控制器(不包括)

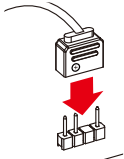
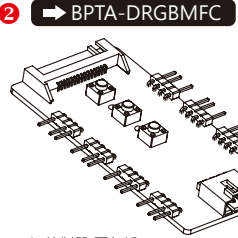
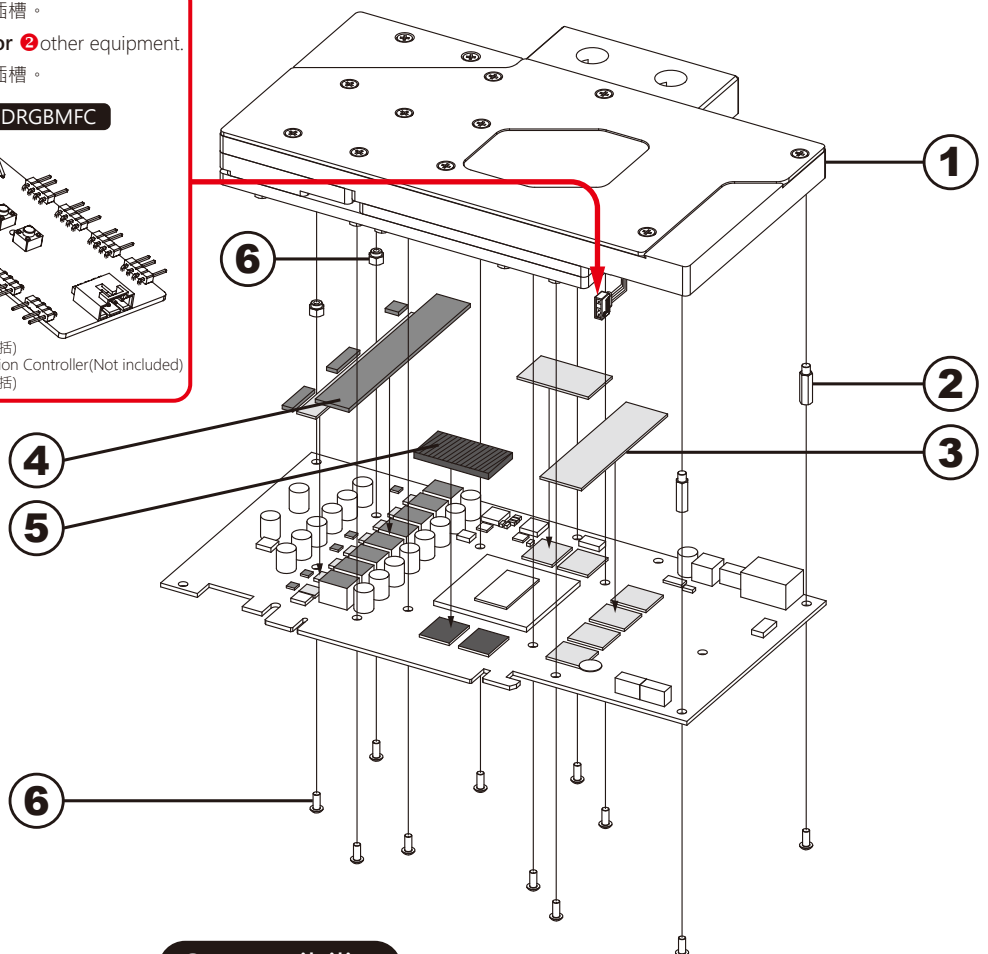

Compatibility

- Colorful GeForce RTX 2060 Gaming GT V2
- Colorful GeForce GTX 1660 Ti Gaming GT 6G
- iGame GeForce GTX 1660 Ti Advanced OC 6G
- iGame GeForce GTX 1660 Ti Ultra 6G

配件

| | | |
|---|---------------|------|
| ① | BPTA-VG2060GX | 1 組 |
| ② | 墊高螺絲A | 2 支 |
| ③ | 1.0 毫米導熱墊片 | 2 片 |
| ④ | 1.5 毫米導熱墊片 | 1 片 |
| ⑤ | 2.5 毫米導熱墊片 | 1 片 |
| ⑥ | 墊高螺絲B | 2 支 |
| ⑦ | M2.5 x 6 毫米螺絲 | 11 支 |

Accessories

| | | |
|---|--------------------|--------|
| ① | BPTA-VG2060GX | 1 SET |
| ② | Booster screw A | 2 PCS |
| ③ | 1.0 mm Thermal pad | 2 PCS |
| ④ | 1.5 mm Thermal pad | 1 PCS |
| ⑤ | 2.5 mm Thermal pad | 1 PCS |
| ⑥ | Booster screw B | 2 PCS |
| ⑦ | M2.5 x 6 mm screw | 11 PCS |



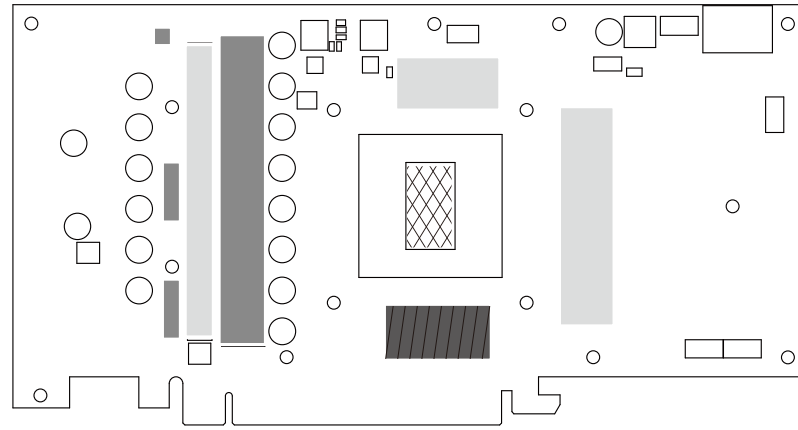

配件

| | | |
|---|---------------|------|
| ① | BPTA-VG2060GX | 1 組 |
| ② | 墊高螺絲A | 2 支 |
| ③ | 1.0 毫米導熱墊片 | 2 片 |
| ④ | 1.5 毫米導熱墊片 | 1 片 |
| ⑤ | 2.5 毫米導熱墊片 | 1 片 |
| ⑥ | 墊高螺絲B | 2 支 |
| ⑦ | M2.5 x 6 毫米螺絲 | 11 支 |









導熱墊片和導熱膏的正確應用位置

-  適量使用導熱膏
-  1 mm導熱墊片
-  1.5 mm導熱墊片
-  2.5 mm導熱墊片





 注意·跑水前·請先確認所有零件已安裝在正確的位置上·在不開主機·單開水泵的情況下·進行24小時的跑水測試·確保無漏水情況後再開主機·避免發生漏水而導致電腦零件的損壞。

Applying the thermal pad and thermal paste on correct positions.

-  Using appropriate amount of thermal paste.
-  1 mm Thermal pad
-  1.5 mm Thermal pad
-  2.5 mm Thermal pad

 Before filling in the water, please make sure all the components are installed correctly. To prevent any leakage which may damage the PC components, please perform a 24-hour leaking test with only the pump connected to the power supply.

导热垫片和导热膏的正确应用位置

-  适量使用导热膏
-  1 毫米导热垫片
-  1.5 毫米导热垫片
-  2.5 毫米导热垫片

 注意·跑水前·请先确认所有零件已安装在正确的位置上·在不开主机·单开水泵的情况下·进行24小时的跑水测试·确保无漏水情况后再开主机·避免发生漏水而导致电脑零件的损坏。



touchaqua

請接**1**主版**或****2**其他設備的DRGB插槽。
 Digital RGB PIN on **1**motherboard **or** **2**other equipment.
 請接**1**主版**或****2**其他設備的DRGB插槽。

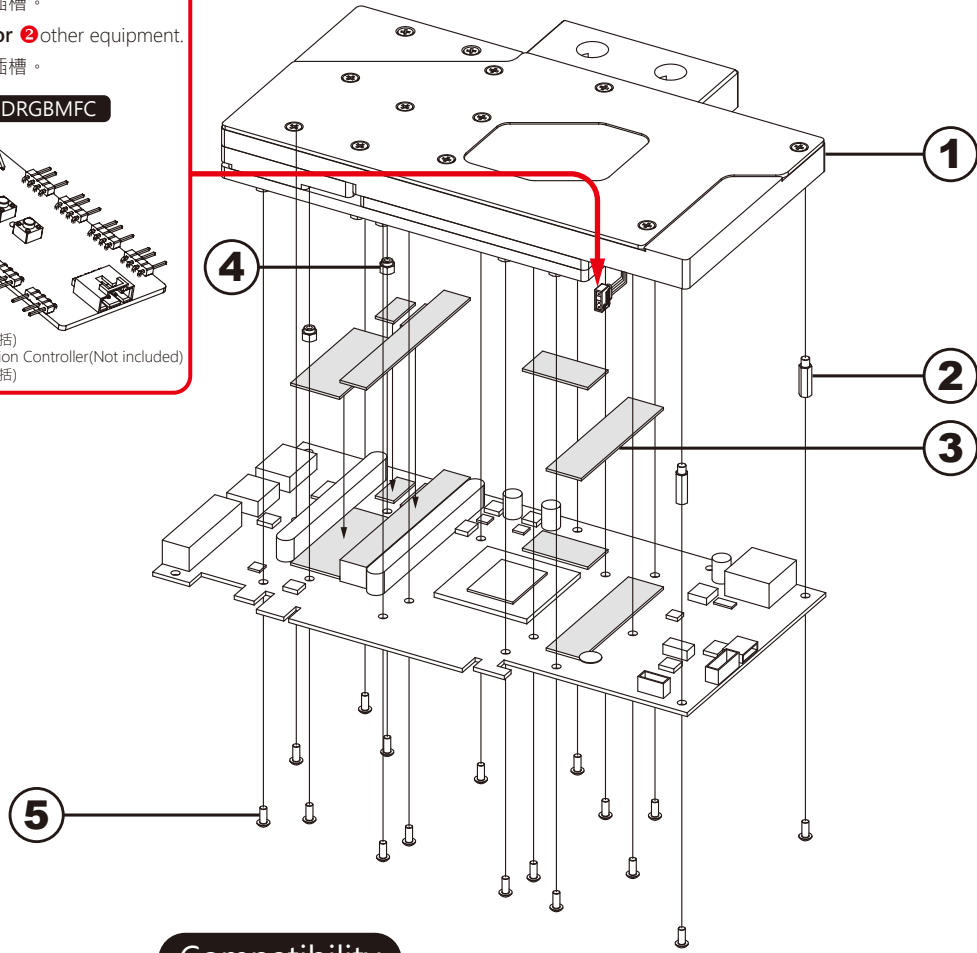
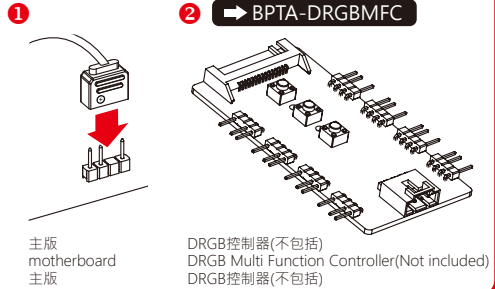

Compatibility

GALAX GeForce RTX 2060大將

配件

| | | |
|---|---------------|------|
| ① | BPTA-VG2060GX | 1 組 |
| ② | 墊高螺絲A | 2 支 |
| ③ | 1.0 毫米導熱墊片 | 3 片 |
| ④ | 墊高螺絲B | 2 支 |
| ⑤ | M2.5 x 6 毫米螺絲 | 17 支 |

Accessories

| | | |
|---|--------------------|--------|
| ① | BPTA-VG2060GX | 1 SET |
| ② | Booster screw A | 2 PCS |
| ③ | 1.0 mm Thermal pad | 3 PCS |
| ④ | Booster screw B | 2 PCS |
| ⑤ | M2.5 x 6 毫米螺絲 | 17 PCS |

配件



| | | |
|---|---------------|------|
| ① | BPTA-VG2060GX | 1 組 |
| ② | 墊高螺絲A | 2 支 |
| ③ | 1.0 毫米導熱墊片 | 3 片 |
| ④ | 墊高螺絲B | 2 支 |
| ⑤ | M2.5 x 6 毫米螺絲 | 17 個 |



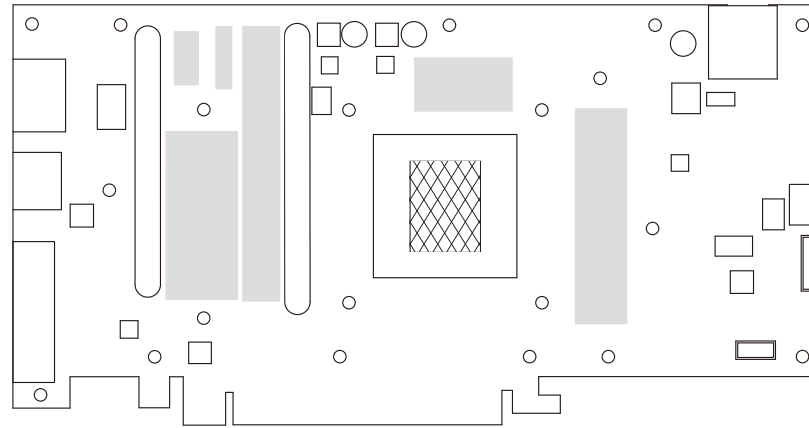

本公司保留對產品的設計更改以及解釋的權力。如有更動恕不另行通知。產品顏色與配件以實物為準。
 Bitspower reserves the right to change the product design and interpretations. These are subject to change without notice. Product colors and accessories are based on the actual product.
 本公司保留對產品設計更改以及解釋的權力。如有更動恕不另行通知。產品顏色與配件以實物為準。





導熱墊片和導熱膏的正確應用位置

-  適量使用導熱膏
-  1 mm導熱墊片

Applying the thermal pad and thermal paste on correct positions.

-  Using appropriate amount of thermal paste.
-  1 mm Thermal pad

导热垫片和导热膏的正确应用位置

-  适量使用导热膏
-  1 毫米导热垫片

 注意·跑水前·請先確認所有零件已安裝在正確的位置上·在不開主機·單開水泵的情況下·進行24小時的跑水測試·確保無漏水情況後再開主機·避免發生漏水而導致電腦零件的損壞。

 Before filling in the water, please make sure all the components are installed correctly. To prevent any leakage which may damage the PC components, please perform a 24-hour leaking test with only the pump connected to the power supply .

 注意·跑水前·請先確認所有零件已安裝在正確的位置上·在不開主機·單開水泵的情況下·進行24小時的跑水測試·確保無漏水情況後再開主機·避免發生漏水而導致電腦零件的損壞。



touchaqua

請接**1**主版**或****2**其他設備的DRGB插槽。
 Digital RGB PIN on **1** motherboard **or** **2** other equipment.
 請接**1**主版**或****2**其他設備的DRGB插槽。

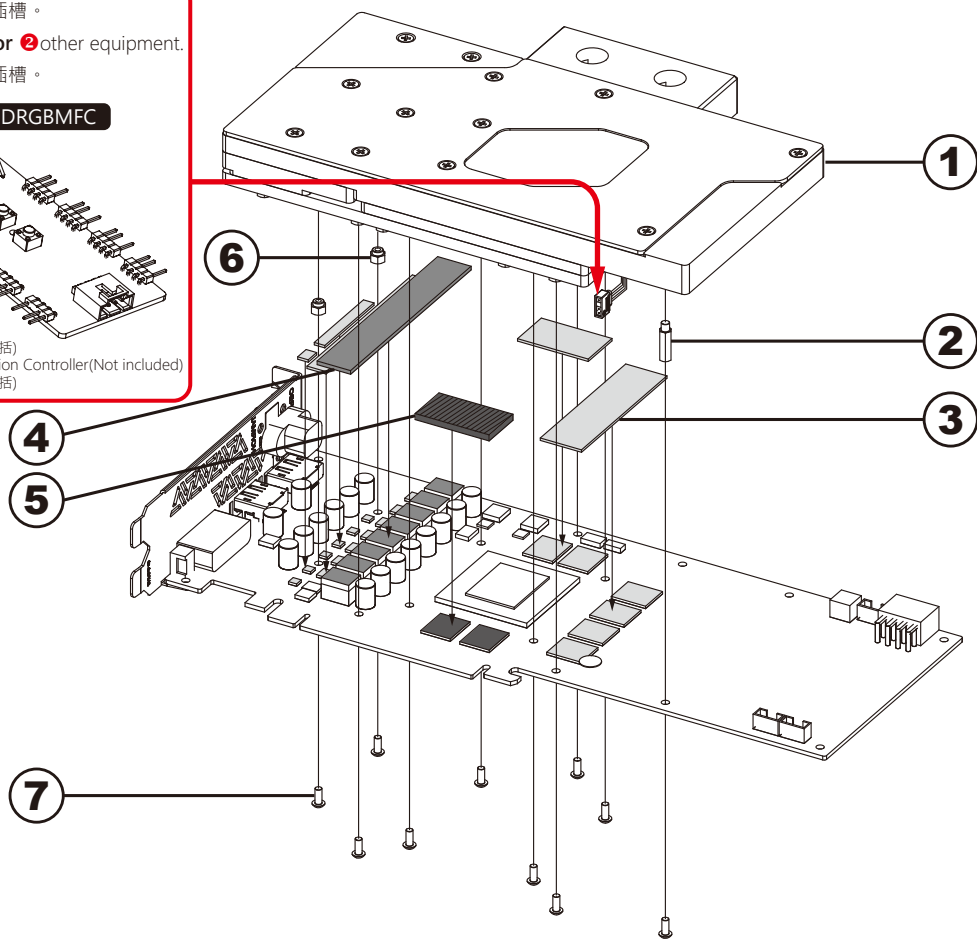
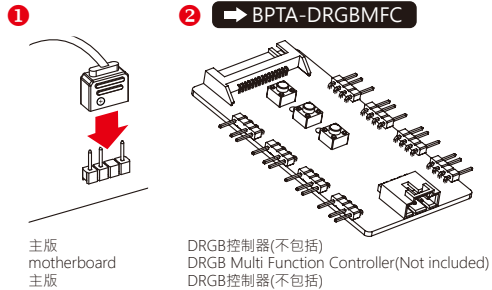

Compatibility

iGame GeForce RTX 2060 Ultra

配件

| | | |
|---|---------------|------|
| ① | BPTA-VG2060GX | 1 組 |
| ② | 墊高螺絲A | 1 支 |
| ③ | 1.0 毫米導熱墊片 | 2 片 |
| ④ | 1.5 毫米導熱墊片 | 1 片 |
| ⑤ | 2.5 毫米導熱墊片 | 1 片 |
| ⑥ | 墊高螺絲B | 2 支 |
| ⑦ | M2.5 x 6 毫米螺絲 | 10 支 |

Accessories

| | | |
|---|--------------------|--------|
| ① | BPTA-VG2060GX | 1 SET |
| ② | Booster screw A | 1 PCS |
| ③ | 1.0 mm Thermal pad | 2 PCS |
| ④ | 1.5 mm Thermal pad | 1 PCS |
| ⑤ | 2.5 mm Thermal pad | 1 PCS |
| ⑥ | Booster screw B | 2 PCS |
| ⑦ | M2.5 x 6 mm screw | 10 PCS |

配件





| | | |
|---|---------------|------|
| ① | BPTA-VG2060GX | 1 組 |
| ② | 墊高螺絲A | 1 支 |
| ③ | 1.0 毫米導熱墊片 | 2 片 |
| ④ | 1.5 毫米導熱墊片 | 1 片 |
| ⑤ | 2.5 毫米導熱墊片 | 1 片 |
| ⑥ | 墊高螺絲B | 2 支 |
| ⑦ | M2.5 x 6 毫米螺絲 | 10 支 |

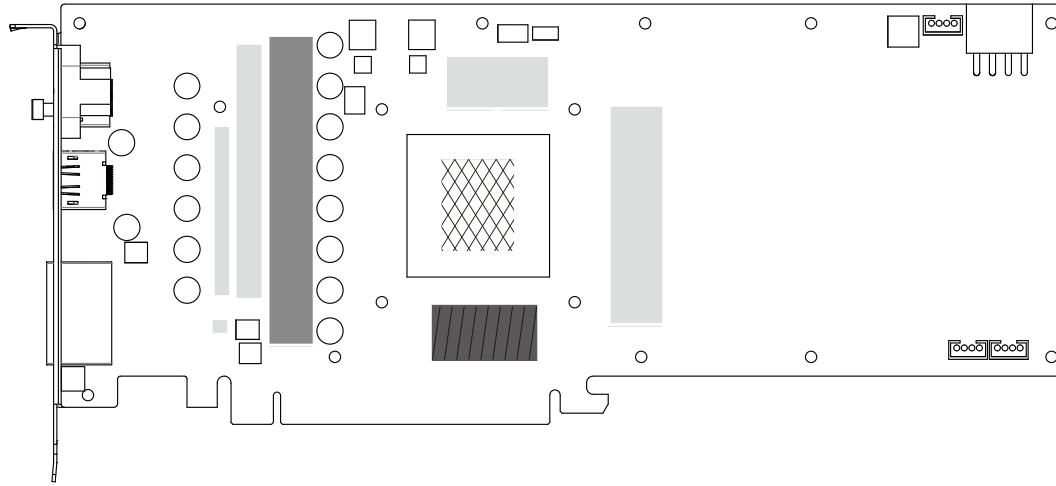





本公司保留對產品的設計更改以及解釋的權力。如有更動恕不另行通知。產品顏色與配件以實物為準。
 Bitspower reserves the right to change the product design and interpretations. These are subject to change without notice. Product colors and accessories are based on the actual product.
 本公司保留對產品的設計更改以及解釋的權力。如有更動恕不另行通知。產品顏色與配件以實物為準。







導熱墊片和導熱膏的正確應用位置

-  適量使用導熱膏
-  1 mm導熱墊片
-  1.5 mm導熱墊片
-  2.5 mm導熱墊片

Applying the thermal pad and thermal paste on correct positions.

-  Using appropriate amount of thermal paste.
-  1 mm Thermal pad
-  1.5 mm Thermal pad
-  2.5 mm Thermal pad

导热垫片和导热膏的正确应用位置

-  适量使用导热膏
-  1 毫米导热垫片
-  1.5 毫米导热垫片
-  2.5 毫米导热垫片

 注意·跑水前·請先確認所有零件已安裝在正確的位置上·在不開主機·單開水泵的情況下·進行24小時的跑水測試·確保無漏水情況後再開主機·避免發生漏水而導致電腦零件的損壞。

 Before filling in the water, please make sure all the components are installed correctly. To prevent any leakage which may damage the PC components, please perform a 24-hour leaking test with only the pump connected to the power supply.

 注意·跑水前·請先確認所有零件已安裝在正確的位置上·在不開主機·單開水泵的情況下·進行24小時的跑水測試·確保無漏水情況後再開主機·避免發生漏水而導致電腦零件的損壞。



touchaqua

注意：Bitspower建議消費者使用蒸餾水、純淨水，加入Bitspower的染劑作為水冷液使用；如客戶自行選購的水冷液導致電鍍層剝落、水道堵塞、水泵轉

 動不正常、水箱管破裂或密封圈變型以致漏水等及其它不可抗力之問題時，消費者自行承擔相關產品責任。
未注水前，請勿啟動水泵電源。

Notice:Bitspower recommends that consumers add the Bitspower dye to distilled water or purified water for their water-cooling liquid. If the consumer chooses different water-cooling liquids, the resulting impurities may cause peeling of the coating on some of the hardware, water channels blockage by built-up residue, improper operation of the water pump, water tank tube breakage, and o-rings deformation leading to leakage. Any issues related to the use of inappropriate water-cooling liquid will be the responsibility of the consumer.
Do not turn on the pump if the reservoir is empty.

注意：Bitspower 建议消费者使用蒸馏水、纯净水，加入Bitspower的染剂作为水冷液使用；如客户自行选购的水冷液导致电镀层剥落、水道堵塞、水泵转

 动不正常、水箱管破裂或密封圈变型以致漏水等及其它不可抗力之问题时，消费者自行承担相关产品责任。
未注水前，请勿启动水泵电源。



注意·跑水前·請先確認所有零件已安裝在正確的位置上·在不開主機·單開水泵的情況下·進行24小時的跑水測試·確保無漏水情況後再開主機·避免發生漏水而導致電腦零件的損壞。

Before fill in water,please make sure all the component be installed correctly,avoidingleaking happen and destroy the PC component.

注意·跑水前·请先确认所有零件已安装在正确的位置上·在不开主机·单开水泵的情况下·进行24小时的跑水测试·确保无漏水情况后开主机·避免发生漏水而导致电脑零件的损坏。

本公司保留對產品的設計更改以及解釋的權力·如有更動恕不另行通知·產品顏色與配件以實物為準。

Bitspower reserves the right to change the product design and interpretations. These are subject to change without notice. Product colors and accessories are based on the actual product.

本公司保留对产品的的设计更改以及解释的权力·如有更动恕不另行通知·产品颜色与配件以实物为准。