

請接**1**主版**或****2**其他設備的DRGB插槽。
 Digital RGB PIN on **1** motherboard **or** **2** other equipment.
 請接**1**主版**或****2**其他設備的DRGB插槽。

1 **2** → BPTA-DRGBMFC

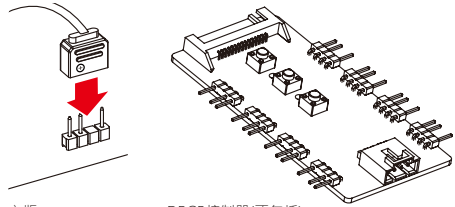

主版
motherboard
主版

DRGB控制器(不包括)
DRGB Multi Function Controller(Not included)
DRGB控制器(不包括)

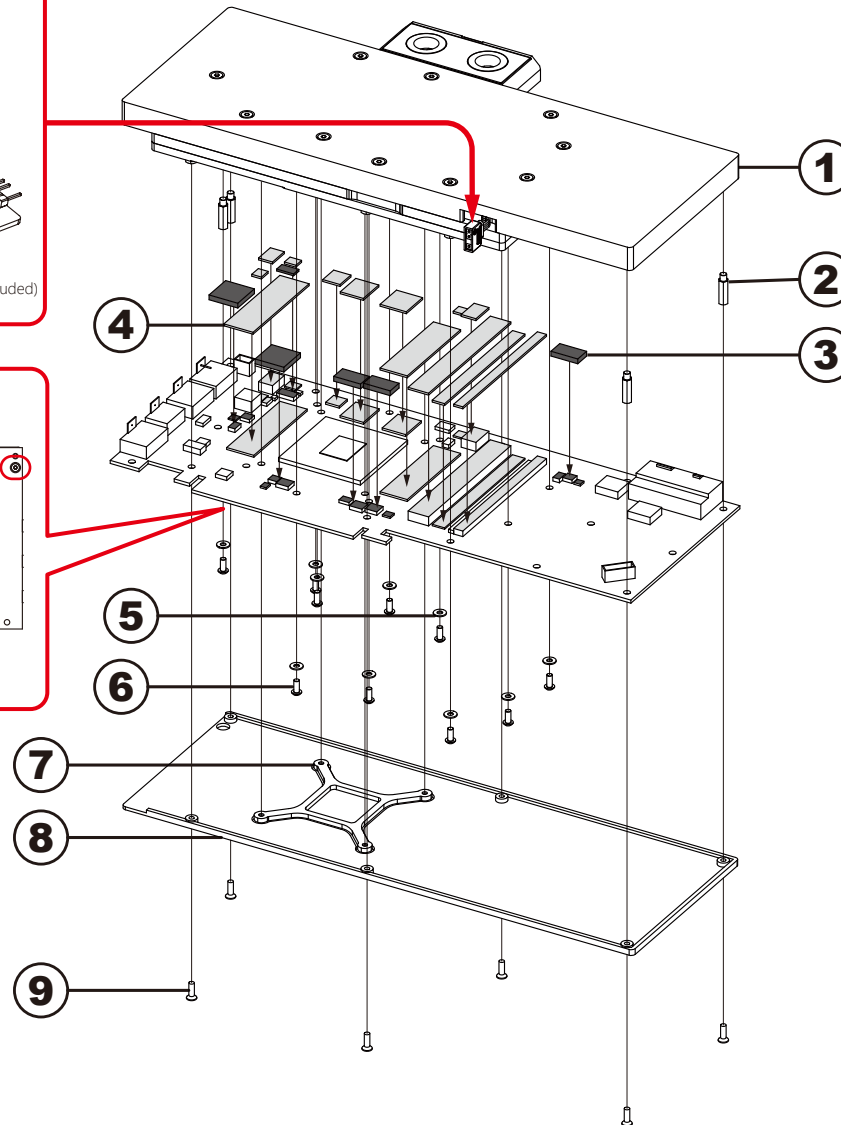
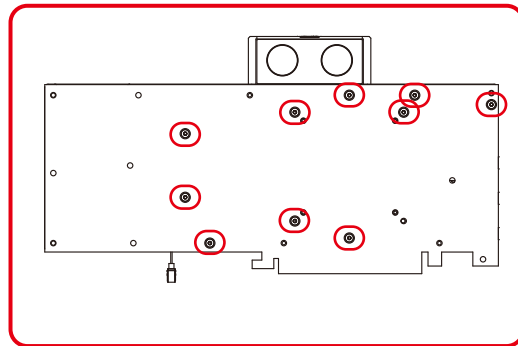

配件

①	BP-VG5700XTRD	1 組
②	墊高螺絲	4 支
③	2.5 mm 導熱墊片	1 片
④	1.0 mm 導熱墊片	4 片
⑤	華司	10 片
⑥	M2.5 x 6毫米螺絲	10 支
⑦	原廠支架 不包括	1 個
⑧	原廠背板 不包括	1 片
⑨	原廠M2.5 x 8十字螺絲 不包括	6 支

Accessories

①	BP-VG5700XTRD	1 PCS
②	Booster screw	4 PCS
③	2.5 mm Thermal pad	1 PCS
④	1.0 mm Thermal pad	4 PCS
⑤	Washer	10 PCS
⑥	M2.5 x 6 mm screw	10 PCS
⑦	Original Bracket Not included	1 PCS
⑧	Original Backplane Not included	1 PCS
⑨	Original M2.5 x 8 mm Phillips screw Not included	6 PCS

配件

①	BP-VG5700XTRD	1 組
②	墊高螺絲	4 支
③	2.5 mm 導熱墊片	1 片
④	1.0 mm 導熱墊片	4 片
⑤	華司	10 片
⑥	M2.5 x 6螺絲	10 支
⑦	原裝支架 不包括	1 個
⑧	原裝背板 不包括	1 片
⑨	原裝M2.5 x 8毫米十字螺絲 不包括	6 支





本公司保留對產品的設計更改以及解釋的權力，如有更動恕不另行通知，產品顏色與配件以實物為準。

Bitspower reserves the right to change the product design and interpretations. These are subject to change without notice. Product colors and accessories are based on the actual product.

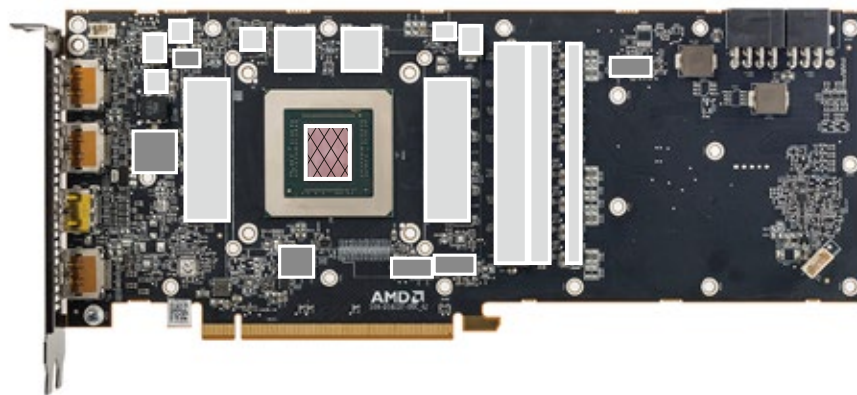

本公司保留對產品的設計更改以及解釋的權力，如有更動恕不另行通知，產品顏色與配件以實物為準。





導熱墊片和導熱膏的正確應用位置

-  適量使用導熱膏
-  1 mm 導熱墊片
-  2.5 mm 導熱墊片

Applying the thermal pad and thermal paste on correct positions.

-  Using appropriate amount of thermal paste.
-  1 mm Thermal pad
-  2.5 mm Thermal pad

导热垫片和导热膏的正确应用位置

-  适量使用导热膏
-  1 毫米导热垫片
-  2.5 毫米导热垫片

 注意·跑水前·請先確認所有零件已安裝在正確的位置上·在不開主機·單開水泵的情況下·進行24小時的跑水測試·確保無漏水情況後再開主機·避免發生漏水而導致電腦零件的損壞。

 Before filling in the water, please make sure all the components are installed correctly. To prevent any leakage which may damage the PC components, please perform a 24-hour leaking test with only the pump connected to the power supply.

 注意·跑水前·請先確認所有零件已安裝在正確的位置上·在不開主機·單開水泵的情況下·進行24小時的跑水測試·確保無漏水情況後再開主機·避免發生漏水而導致電腦零件的損壞。



Bitspower[®]

注意：Bitspower建議消費者使用蒸餾水、純淨水，加入Bitspower的染劑作為水冷液使用；如客戶自行選購的水冷液導致電鍍層剝落、水道堵塞、水泵轉



動不正常、水箱管破裂或密封圈變型以致漏水等及其它不可抗力之問題時，消費者自行承擔相關產品責任。

未注水前，請勿啟動水泵電源。

Notice:Bitspower recommends that consumers add the Bitspower dye to distilled water or purified water for their water-cooling liquid. If the



consumer chooses different water-cooling liquids, the resulting impurities may cause peeling of the coating on some of the hardware, water channels blockage by built-up residue, improper operation of the water pump, water tank tube breakage, and o-rings deformation leading to leakage. Any issues related to the use of inappropriate water-cooling liquid will be the responsibility of the consumer.

Do not turn on the pump if the reservoir is empty.

注意：Bitspower 建议消费者使用蒸馏水、纯净水，加入Bitspower的染剂作为水冷液使用；如客户自行选购的水冷液导致电镀层剥落、水道堵塞、水泵转



动不正常、水箱管破裂或密封圈变型以致漏水等及其它不可抗力之问题时，消费者自行承担相关产品责任。

未注水前，请勿启动水泵电源。



注意·跑水前·請先確認所有零件已安裝在正確的位置上·在不開主機·單開水泵的情況下·進行24小時的跑水測試·確保無漏水情況後再開主機·避免發生漏水而導致電腦零件的損壞。

Before fill in water,please make sure all the component be installed correctly,avoidingleaking happen and destroy the PC component.

注意·跑水前·請先確認所有零件已安裝在正確的位置上·在不開主機·單開水泵的情況下·進行24小時的跑水測試·確保無漏水情況後再開主機·避免發生漏水而導致電腦零件的損壞。

本公司保留對產品的設計更改以及解釋的權力·如有更動恕不另行通知·產品顏色與配件以實物為準。

Bitspower reserves the right to change the product design and interpretations. These are subject to change without notice. Product colors and accessories are based on the actual product.

本公司保留對產品的設計更改以及解釋的權力·如有更動恕不另行通知·產品顏色與配件以實物為準。