

請接 ① 主版或 ② 其他設備的DRGB插槽。
 Digital RGB PIN on ① motherboard or ② other equipment.
 請接 ① 主版或 ② 其他設備的DRGB插槽。

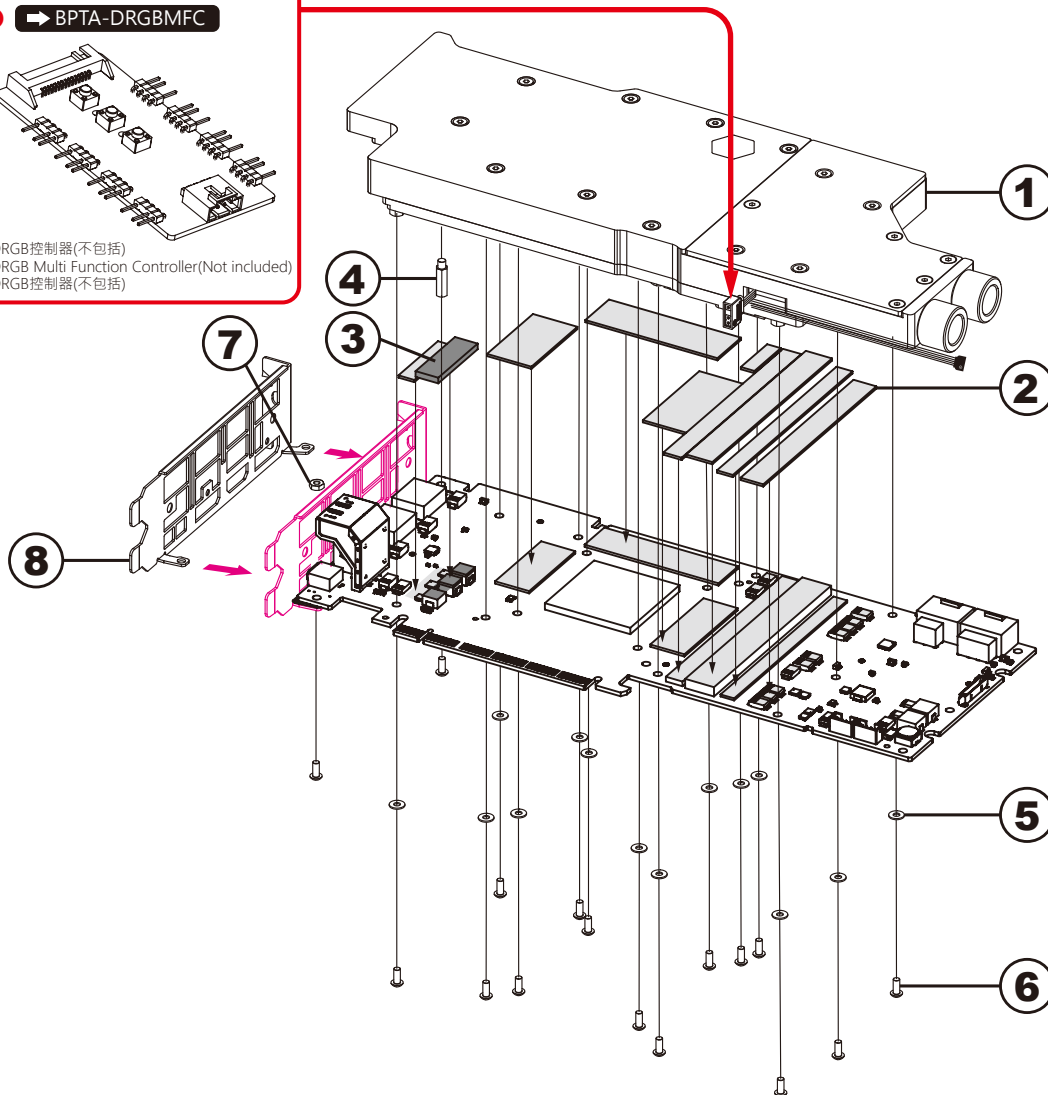
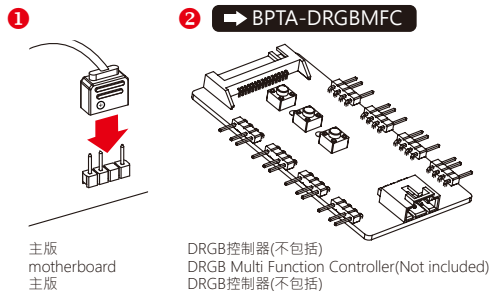

配件

①	BP-VG2080RDS	1 組
②	1.0 毫米導熱墊片	5 片
③	2.5 毫米導熱墊片	6 片
④	墊高螺絲	1 支
⑤	0.5 毫米華司	14 片
⑥	M2.5 x 6 毫米螺絲	16 支
⑦	M2.5 螺母	1 個
⑧	原廠擋板	1 個

Accessories

①	BP-VG2080RDS	1 SET
②	1.0 mm Thermal pad	5 PCS
③	2.5 mm Thermal pad	6 PCS
④	Booster Screw	1 PCS
⑤	0.5 mm Washer	14 PCS
⑥	M2.5 x 6 mm Screw	16 PCS
⑦	M2.5 Nut	1 PCS
⑧	Original baffle	1 PCS

配件



①	BP-VG2080RDS	1 組
②	1.0 毫米導熱墊片	5 片
③	2.5 毫米導熱墊片	6 片
④	墊高螺絲	1 支
⑤	0.5 毫米華司	14 片
⑥	M2.5 x 6 毫米螺絲	16 支
⑦	M2.5 螺母	1 個
⑧	原廠擋板	1 個

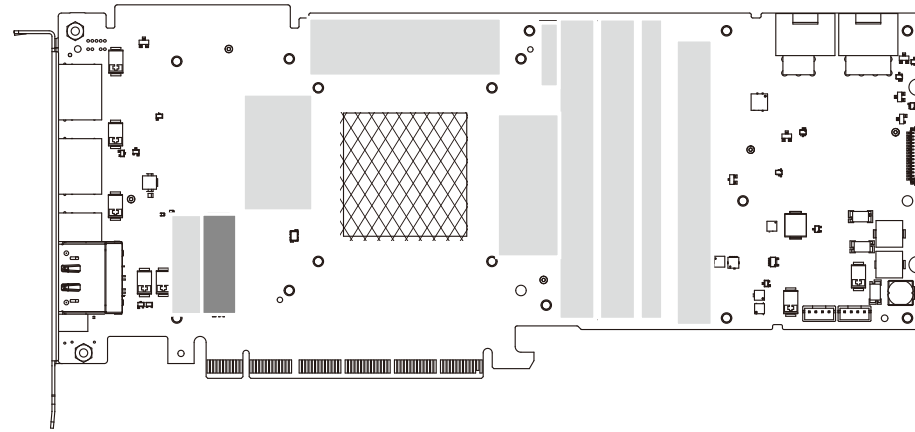





NVIDIA GEFORCE RTX 2080



導熱墊片和導熱膏的正確應用位置

-  適量使用導熱膏
-  1 mm 導熱墊片
-  2.5 mm 導熱墊片

Applying the thermal pad and thermal paste on correct positions.

-  Using appropriate amount of thermal paste.
-  1 mm Thermal pad
-  2.5 mm Thermal pad

导热垫片和导热膏的正确应用位置

-  適量使用導熱膏
-  1 mm 導熱墊片
-  2.5 mm 導熱墊片

 注意：跑水前，請先確認所有零件已安裝在正確的位置上。在不開主機，單開水泵的情況下，進行24小時的跑水測試，確保無漏水情況後再開主機，避免發生漏水而導致電腦零件的損壞。

 Before filling in the water, please make sure all the components are installed correctly. To prevent any leakage which may damage the PC components, please perform a 24-hour leaking test with only the pump connected to the power supply.

 注意：跑水前，請先確認所有零件已安裝在正確的位置上。在不開主機，單開水泵的情況下，進行24小時的跑水測試，確保無漏水情況後再開主機，避免發生漏水而導致電腦零件的損壞。

請接**1**主版或**2**其他設備的DRGB插槽。
 Digital RGB PIN on **1**motherboard or **2**other equipment.
 請接**1**主版或**2**其他設備的DRGB插槽。

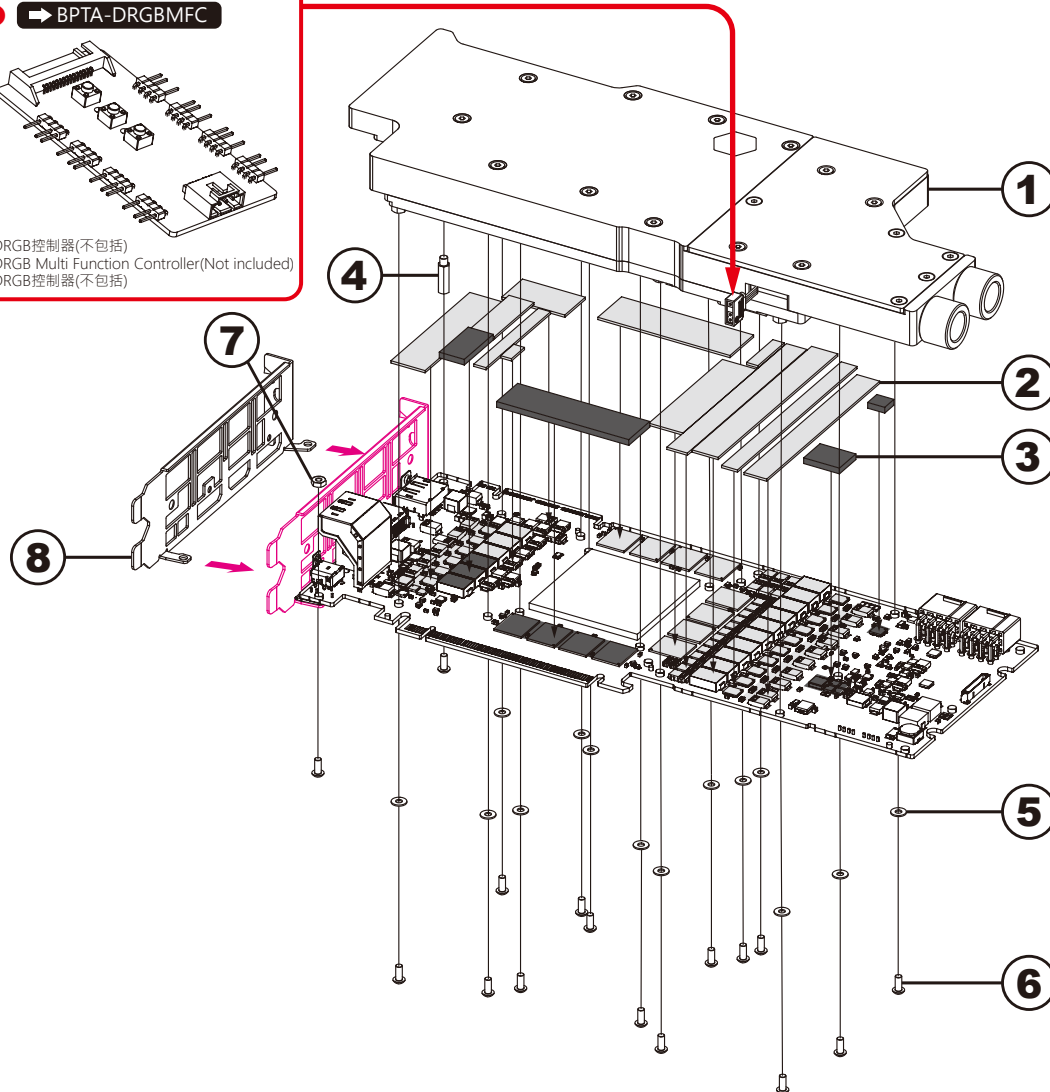
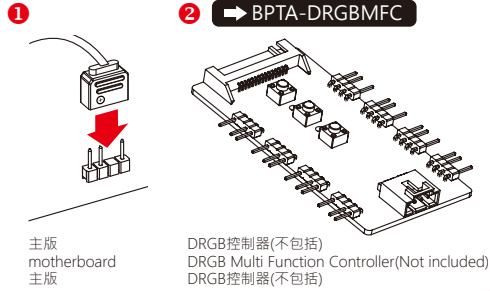

配件

①	BP-VG2080RDS	1 組
②	1.0 毫米導熱墊片	5 片
③	2.5 毫米導熱墊片	6 片
④	墊高螺絲	1 支
⑤	0.5 毫米華司	14 片
⑥	M2.5 x 6 毫米螺絲	16 支
⑦	M2.5 螺母	1 個
⑧	原廠擋板	1 個

Accessories

①	BP-VG2080RDS	1 SET
②	1.0 mm Thermal pad	5 PCS
③	2.5 mm Thermal pad	6 PCS
④	Booster Screw	1 PCS
⑤	0.5 mm Washer	14 PCS
⑥	M2.5 x 6 mm Screw	16 PCS
⑦	M2.5 Nut	1 PCS
⑧	Original baffle	1 PCS

配件

①	BP-VG2080RDS	1 組
②	1.0 毫米導熱墊片	5 片
③	2.5 毫米導熱墊片	6 片
④	墊高螺絲	1 支
⑤	0.5 毫米華司	14 片
⑥	M2.5 x 6 毫米螺絲	16 支
⑦	M2.5 螺母	1 個
⑧	原廠擋板	1 個



本公司保留對產品的設計更改以及解釋的權力。如有更動恕不另行通知。產品顏色與配件以實物為準。

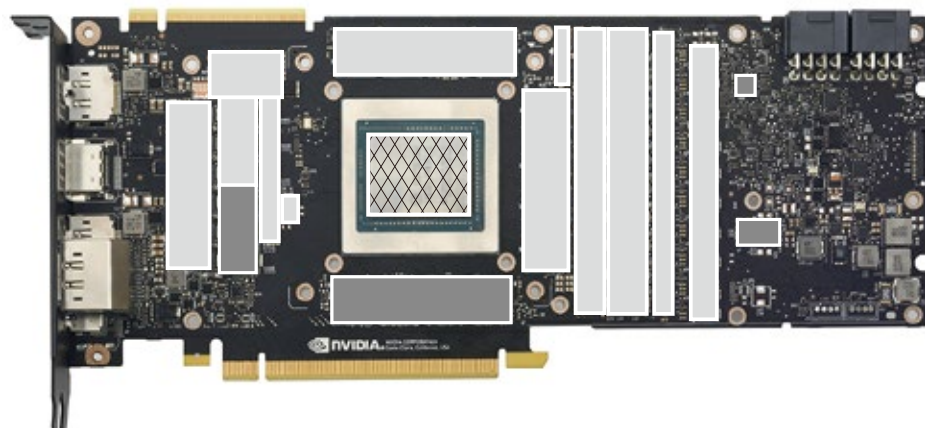

Bitspower reserves the right to change the product design and interpretations. These are subject to change without notice. Product colors and accessories are based on the actual product.

本公司保留對產品的設計更改以及解釋的權力。如有更動恕不另行通知。產品顏色與配件以實物為準。





NVIDIA GEFORCE RTX 2080Ti



導熱墊片和導熱膏的正確應用位置

-  適量使用導熱膏
-  1 mm 導熱墊片
-  2.5 mm 導熱墊片

Applying the thermal pad and thermal paste on correct positions.

-  Using appropriate amount of thermal paste.
-  1 mm Thermal pad
-  2.5 mm Thermal pad

导热垫片和导热膏的正确应用位置

-  適量使用導熱膏
-  1 mm 導熱墊片
-  2.5 mm 導熱墊片

 注意，跑水前，請先確認所有零件已安裝在正確的位置上。在不開主機，單開水泵的情況下，進行24小時的跑水測試，確保無漏水情況後再開主機，避免發生漏水而導致電腦零件的損壞。

 Before filling in the water, please make sure all the components are installed correctly. To prevent any leakage which may damage the PC components, please perform a 24-hour leaking test with only the pump connected to the power supply.

 注意，跑水前，請先確認所有零件已安裝在正確的位置上。在不開主機，單開水泵的情況下，進行24小時的跑水測試，確保無漏水情況後再開主機，避免發生漏水而導致電腦零件的損壞。

本公司保留對產品的設計更改以及解釋的權力，如有更動恕不另行通知，產品顏色與配件以實物為準。

Bitspower reserves the right to change the product design and interpretations. These are subject to change without notice. Product colors and accessories are based on the actual product.

本公司保留對產品的设计更改以及解释的权力，如有更动恕不另行通知，产品颜色与配件以实物为准。



Bitspower[®]

注意：Bitspower建議消費者使用蒸餾水、純淨水，加入Bitspower的染劑作為水冷液使用；如客戶自行選購的水冷液導致電鍍層剝落、水道堵塞、水泵轉



動不正常、水箱管破裂或密封圈變型以致漏水等及其它不可抗力之問題時，消費者自行承擔相關產品責任。

未注水前，請勿啟動水泵電源。

Notice:Bitspower recommends that consumers add the Bitspower dye to distilled water or purified water for their water-cooling liquid. If the



consumer chooses different water-cooling liquids, the resulting impurities may cause peeling of the coating on some of the hardware, water channels blockage by built-up residue, improper operation of the water pump, water tank tube breakage, and o-rings deformation leading to leakage. Any issues related to the use of inappropriate water-cooling liquid will be the responsibility of the consumer.

Do not turn on the pump if the reservoir is empty.

注意：Bitspower建议消费者使用蒸馏水、纯净水，加入Bitspower的染剂作为水冷液使用；如客户自行选购的水冷液导致电镀层剥落、水道堵塞、水泵转



动不正常、水箱管破裂或密封圈变型以致漏水等及其它不可抗力之问题时，消费者自行承担相关产品责任。

未注水前，请勿启动水泵电源。



注意，跑水前，請先確認所有零件已安裝在正確的位置上，在不開主機，單開水泵的情況下，進行24小時的跑水測試，確保無漏水情況後再開主機，避免發生漏水而導致電腦零件的損壞。
Before fill in water, please make sure all the component be installed correctly, avoiding leaking happen and destroy the PC component.

注意，跑水前，請先確認所有零件已安裝在正確的位置上，在不開主機，單開水泵的情況下，進行24小時的跑水測試，確保無漏水情況後再開主機，避免發生漏水而導致電腦零件的損壞。

本公司保留對產品的設計更改以及解釋的權力，如有更動恕不另行通知，產品顏色與配件以實物為準。

Bitspower reserves the right to change the product design and interpretations. These are subject to change without notice. Product colors and accessories are based on the actual product.

本公司保留對產品的設計更改以及解釋的權力，如有更動恕不另行通知，產品顏色與配件以實物為準。