



Bitspower®

ASROCK X570 TAICHI

請接 ① 主版或 ② 其他設備的DRGB插槽。

Digital RGB PIN on ① motherboard or ② other equipment.

請接 ① 主版或 ② 其他設備的DRGB插槽。

①

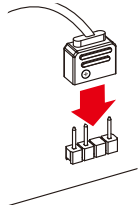

主版
motherboard
主版

②

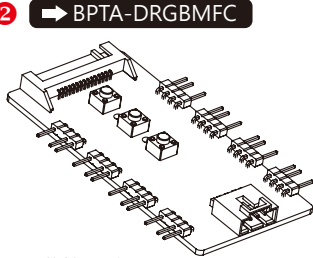

DRGB控制器(不包括)
DRGB Multi Function Controller(Not included)
DRGB控制器(不包括)

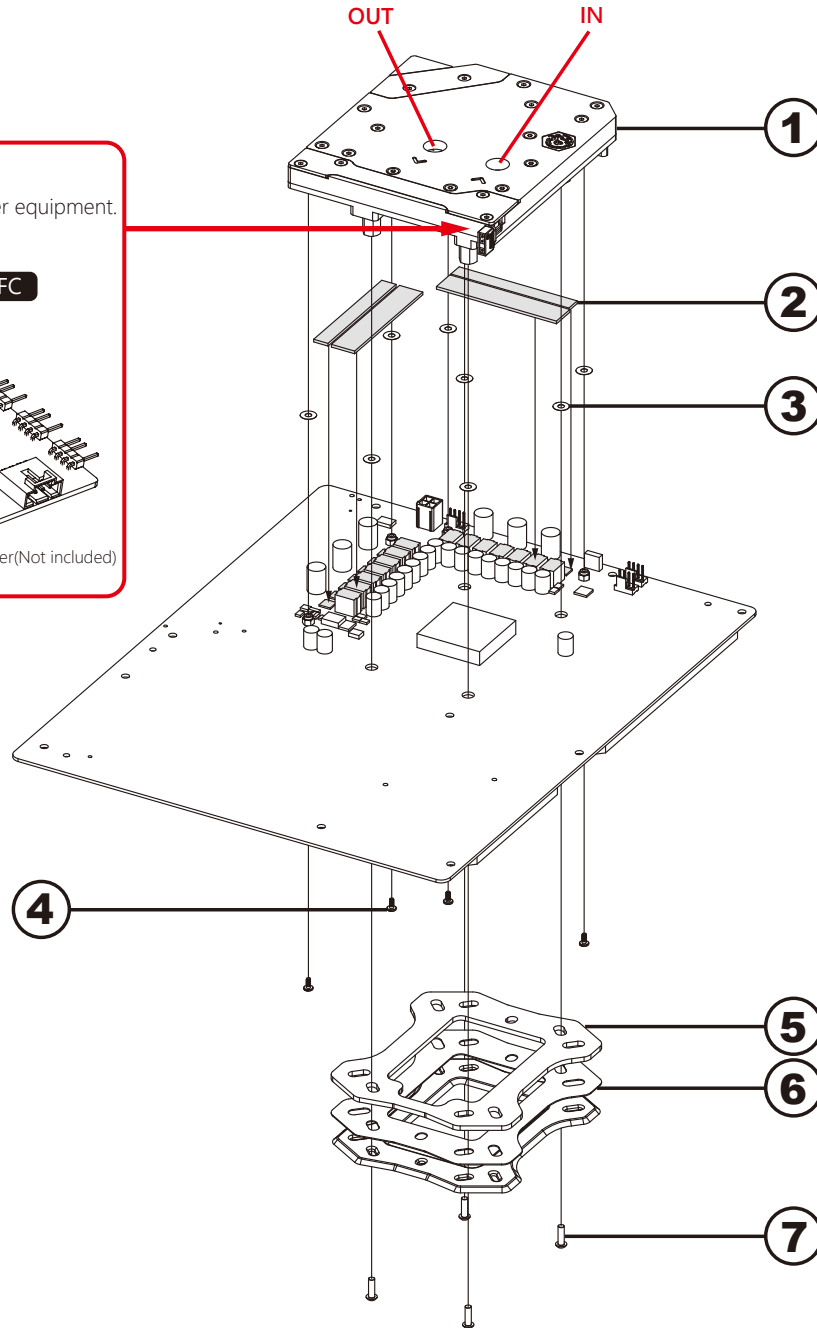

配件

①	BP-MBASRX570TC	1 組
②	1.5 毫米導熱墊片	3 片
③	背膠華司	8 片
④	原廠螺絲	4 支
⑤	背板墊片	1 片
⑥	3M背膠絕緣片	1 片
⑦	金屬背板	1 片
⑧	M3 x 10 毫米螺絲	4 支

Accessories

①	BP-MBASRX570TC	1 SET
②	1.5 mm Thermal pad	3 PCS
③	Washer With Gum	8 PCS
④	Washer	4 PCS
⑤	Back Pad	1 PCS
⑥	3M Paste pad	1 PCS
⑦	Metal backplane	1 PCS
⑧	M3 x 10 mm Screw	4 PCS

配件

①	BP-MBASRX570TC	1 組
②	1.5 毫米導熱墊片	3 片
③	背膠華司	8 片
④	原廠螺絲	4 支
⑤	背板墊片	1 片
⑥	3M背膠絕緣片	1 片
⑦	金屬背板	1 片
⑧	M3 x 10 毫米螺絲	4 支



本公司保留對產品的設計更改以及解釋的權力。如有更動恕不另行通知。產品顏色與配件以實物為準。

Bitspower reserves the right to change the product design and interpretations. These are subject to change without notice. Product colors and accessories are based on the actual product.

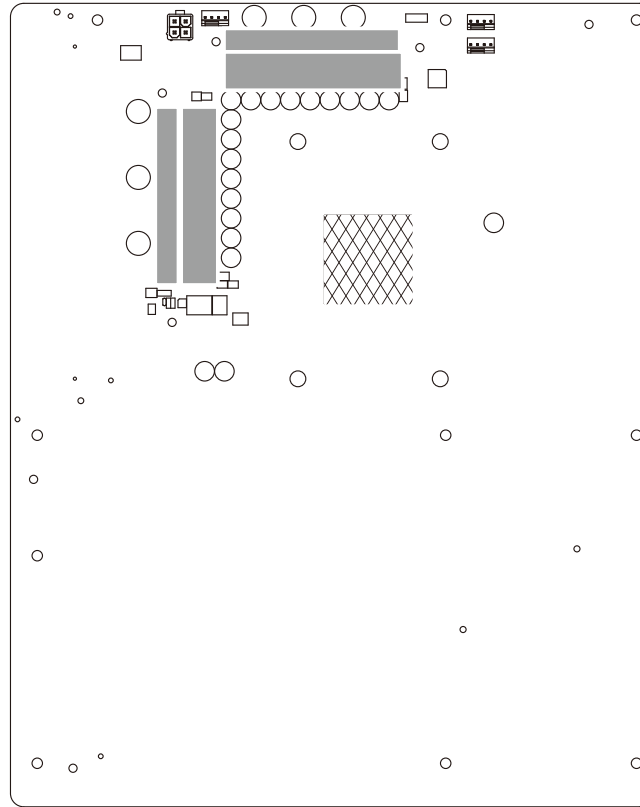

本公司保留對產品的設計更改以及解釋的權力。如有更動恕不另行通知。產品顏色與配件以實物為準。





導熱墊片和導熱膏的正確應用位置

-  適量使用導熱膏
-  1.5 MM導熱墊片

Applying the thermal pad and thermal paste on correct positions.

-  Using appropriate amount of thermal paste.
-  1.5 mm Thermal pad

导热垫片和导热膏的正确应用位置

-  适量使用导热膏
-  1.5 毫米导热垫片

 注意：跑水前，請先確認所有零件已安裝在正確的位置上，在不開主機，單開水泵的情況下，進行24小時的跑水測試，確保無漏水情況後再開主機，避免發生漏水而導致電腦零件的損壞。

 Before filling in the water, please make sure all the components are installed correctly. To prevent any leakage which may damage the PC components, please perform a 24-hour leaking test with only the pump connected to the power supply .

 注意：跑水前，請先確認所有零件已安裝在正確的位置上，在不開主機，單開水泵的情況下，進行24小時的跑水測試，確保無漏水情況後再開主機，避免發生漏水而導致電腦零件的損壞。



Bitspower[®]

注意：Bitspower建議消費者使用蒸餾水、純淨水，加入Bitspower的染劑作為水冷液使用；如客戶自行選購的水冷液導致電鍍層剝落、水道堵塞、水泵轉

 動不正常、水箱管破裂或密封圈變型以致漏水等及其它不可抗力之問題時，消費者自行承擔相關產品責任。
未注水前，請勿啟動水泵電源。

Notice:Bitspower recommends that consumers add the Bitspower dye to distilled water or purified water for their water-cooling liquid. If the

 consumer chooses different water-cooling liquids, the resulting impurities may cause peeling of the coating on some of the hardware, water channels blockage by built-up residue, improper operation of the water pump, water tank tube breakage, and o-rings deformation leading to leakage. Any issues related to the use of inappropriate water-cooling liquid will be the responsibility of the consumer.
Do not turn on the pump if the reservoir is empty.

注意：Bitspower 建议消费者使用蒸馏水、纯净水，加入Bitspower的染剂作为水冷液使用；如客户自行选购的水冷液导致电镀层剥落、水道堵塞、水泵转

 动不正常、水箱管破裂或密封圈变型以致漏水等及其它不可抗力之问题时，消费者自行承担相关产品责任。
未注水前，请勿启动水泵电源。



注意·跑水前·請先確認所有零件已安裝在正確的位置上·在不開主機·單開水泵的情況下·進行24小時的跑水測試·確保無漏水情況後再開主機·避免發生漏水而導致電腦零件的損壞。
Before fill in water,please make sure all the component be installed correctly,avoidingleaking happen and destroy the PC component.

注意·跑水前·請先確認所有零件已安裝在正確的位置上·在不開主機·單開水泵的情況下·進行24小時的跑水測試·確保無漏水情況後再開主機·避免發生漏水而導致電腦零件的損壞。

本公司保留對產品的設計更改以及解釋的權力·如有更動恕不另行通知·產品顏色與配件以實物為準。

Bitspower reserves the right to change the product design and interpretations. These are subject to change without notice. Product colors and accessories are based on the actual product.

本公司保留對產品的設計更改以及解釋的權力·如有更動恕不另行通知·產品顏色與配件以實物為準。